

**HANDRAIL SYSTEMS**

API offers a variety of Handrail Systems, from simple cap and base applications to ornamental railings with verticals and intermediates that can be arranged in an endless array of unique and attractive patterns, creating striking results.

**AVAILABLE OPTIONS**

API's Handrail systems are available in a wide variety of materials, colors, and finishes to compliment and enhance the appearance of any décor. Hundreds of anodized and powder coat colors open up a world of design possibilities.







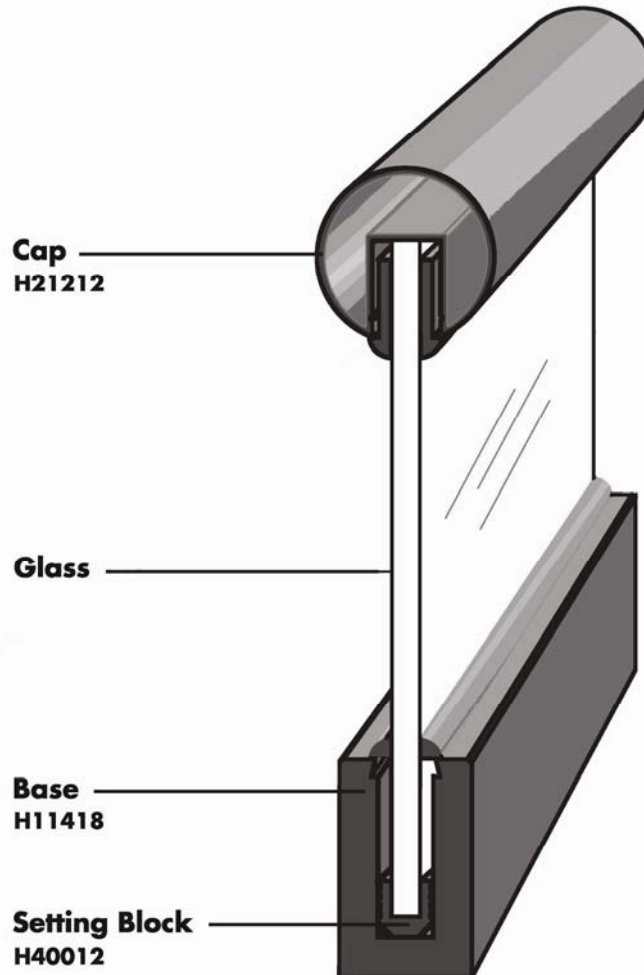

Standard glass Handrail Systems are designed for 1/2" and 3/4" tempered glass. Pre-manufactured radius corners, mitered corners, connector sleeves, and end caps are available for a complete and professional installation. Mounting brackets are also available for wall mount applications.

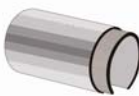

**OPTIONAL FEATURES**

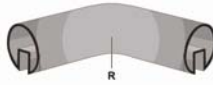
In addition, all of API's Handrail Systems provide a structurally sound railing without compromising visual space, making our handrail a favorite among architects and designers.

API also offers Custom Designed Handrail Systems for those special projects. Let API manufacture your custom design, or if you need inspiration, just share your ideas with us and let our design team create a customized system just for you. Simple complete the Specialty Design form...



<b>ROUND CAP</b>			
DESCRIPTION	PART NUMBER	FINISH	LIST PRICE/ UNIT
 <p>3" Round Cap with 1" x 1-1/4" Pocket</p>	H21103	Clear	Quote
	H22300	Bronze	Quote
	H23300	Powder Coat	Quote
	H25300	Stainless Steel	Quote
Call for additional sizes and gauges			
<b>SQUARE CAP</b>			
 <p>2" x 6" Square Cap with 3/4" Pocket</p>	H21600	Clear	Quote
	H22600	Bronze	Quote
	H23600	Powder Coat	Quote
	H25600	Stainless Steel	Quote
Call for additional sizes and gauges			
<b>CONNECTOR SLEEVE</b>			
 <p>Connector Sleeve to Use with Cap</p>	H70275	For use with H21103	Quote
	H70287	For use with H25300	Quote
Call for additional sizes and gauges			
<b>MITERED CORNER ELBOW</b>			
 <p>3" x 2-1/2" with 3/4" Pocket</p>	H61212	Clear	Quote
	H62212	Bronze	Quote
	H64212	Powder Coat	Quote
	H64212	Stainless Steel	Quote
Call for additional sizes and gauges			
 <p>Corner Elbow 3" Radius</p>	H81190	Clear	Quote
	H82190	Bronze	Quote
	H83190	Powder Coat	Quote
	H84190	Stainless Steel	Quote
Call for additional sizes and gauges			
<b>END CAP</b>			
 <p>3" End Cap</p>	H51300	Clear	Quote
	H52300	Bronze	Quote
	H53300	Powder Coat	Quote
	H54300	Stainless Steel	Quote
Call for additional sizes and gauges			
<b>ACCESORIES</b>			
 <p>Vinyl Insert</p>	H30201	1" x 3/4"	Quote
	H30214	1-1/4" x 3/4"	Quote
	H30414	1-1/4" x 1"	Quote
 <p>Setting Block</p>	H40012	1" for 1/2" Pocket	Quote
	H40034	1-1/4" for 3/4" Pocket	Quote

<b>BASES</b>			
DESCRIPTION	PART NUMBER	FINISH	LIST PRICE/ UNIT
 2-3/4" x 4-1/4" with 1-1/4" Pocket	H11414	Clear	Quote
		Bronze	Quote
		Stainless Steel	Quote
		Powder Coat	Quote
 2-1/2" x 5" x 3"	H11532	Clear	Quote
		Bronze	Quote
		Stainless Steel	Quote
		Powder Coat	Quote
 2-1/2" x 4-1/8" with 1" Pocket	H11212	Clear	Quote
		Bronze	Quote
		Stainless Steel	Quote
		Powder Coat	Quote

www.americanprod.com Email: bids@americanprod.com

Phone: 813-925-0144 Fax: 813-925-1414

